

EN

**motorline**<sup>®</sup>  
PROFESSIONAL

 **The  
GATE GROUP**

09 421 1533 • [sales@thegategroup.co.nz](mailto:sales@thegategroup.co.nz)

R20241227



# GALO

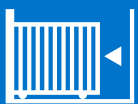

36V brushless motor  
For very intensive use

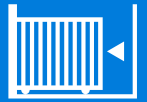

36Vdc



Very Intensive Use



Obstacle detection



Brushless Motor

# GALO

36Vdc motor, with **high performance and speed**, for sliding gates weighing up to 2200Kg (with 4 versions available).

The absence of brushes and the lubricated gearbox guarantee very intensive use with high performance.

# Unrivalled durability Superior performance

The absence of brushes and the lubricated gearbox guarantee intensive use and high performance.

Innovative sliding structure that guarantees speeds of up to 260 mm/sec for gates weighing up to 1200 kg.



## Obstacle Detection

Constant monitoring of impact forces and immediate detection of obstacles for safe operation.



## Native Encoder

It allows precise control of the gate position and ensures that decelerations and movement reversals are accurate.

- Smooth Movement
- Less mechanical wear
- Durability



## Integrated battery charger

Continuous operation even in the event of a power outage.



## Integrated receiver

Capable of storing up to 200 rolling codes at 433.92 MHz.

## Ultra-fast motor

Our motor of up to 600kg, **GALO600 SPEED**, is the fastest motor on the market.



# 450MM/S

Equipped with Brushless technology, it reaches maximum speeds of **450mm/s**, depending on the weight of the gate. However, when operating with the maximum allowed weight, it reaches a speed of 400mm/s.

# 600KG 1200KG 2200KG

## 4 models available

GALO is available for gates weighing up to **600Kg** (GALO600 and GALO600 SPEED), up to **1200Kg** (GALO1200) and up to **2200Kg** (GALO2200).



# Electronic control board

## MC91BL-SC

Compatible with the MCONNECT LINK device for management and control via the MCONNECT app



Download  
MCONNECT APP

MC91BL-SC



### Compatible with MCONNECT LINK

More convenience and efficiency:

- Adjust gate opening and closing times directly from your smartphone, wherever you are
- Receive real-time alerts whenever the gate is used
- See detailed actions history

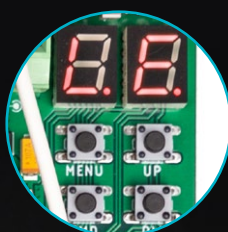

### Intuitive interface

Easily check device status via the programming display or LEDs.



### Autoprogramming

Electronic control board with display and navigation buttons for simplified installation in just two steps.



### Precise adjustments

Full control of position and speed at any time, with specific adjustments for acceleration, deceleration, start time, deceleration distance and approach speed during opening and closing.

## For places without Wi-Fi connection M200 and M250 Communicators

Ensure a **stable and secure connection** through 4G LTE and ensure GALO runs smoothly.

Advanced security and access control features to provide convenience for professionals and peace of mind for users.

MCONTROL app available for download in stores



# Why the Brushless version?

	DC (BRUSH) MOTORS	AC MOTORS	BRUSHLESS MOTORS
Price	●●●	●●●	●●●
Speed	●●●	●●●	●●●
Torque	●●●	●●●	●●●
Smooth movement	●●●	●●●	●●●
Energy consumption efficiency	●●●	●●●	●●●
Acceleration and deceleration accuracy	●●●	●●●	●●●
Speed maintenance	●●●	●●●	●●●
Torque adjustment	●●●	●●●	●●●



## Installation example

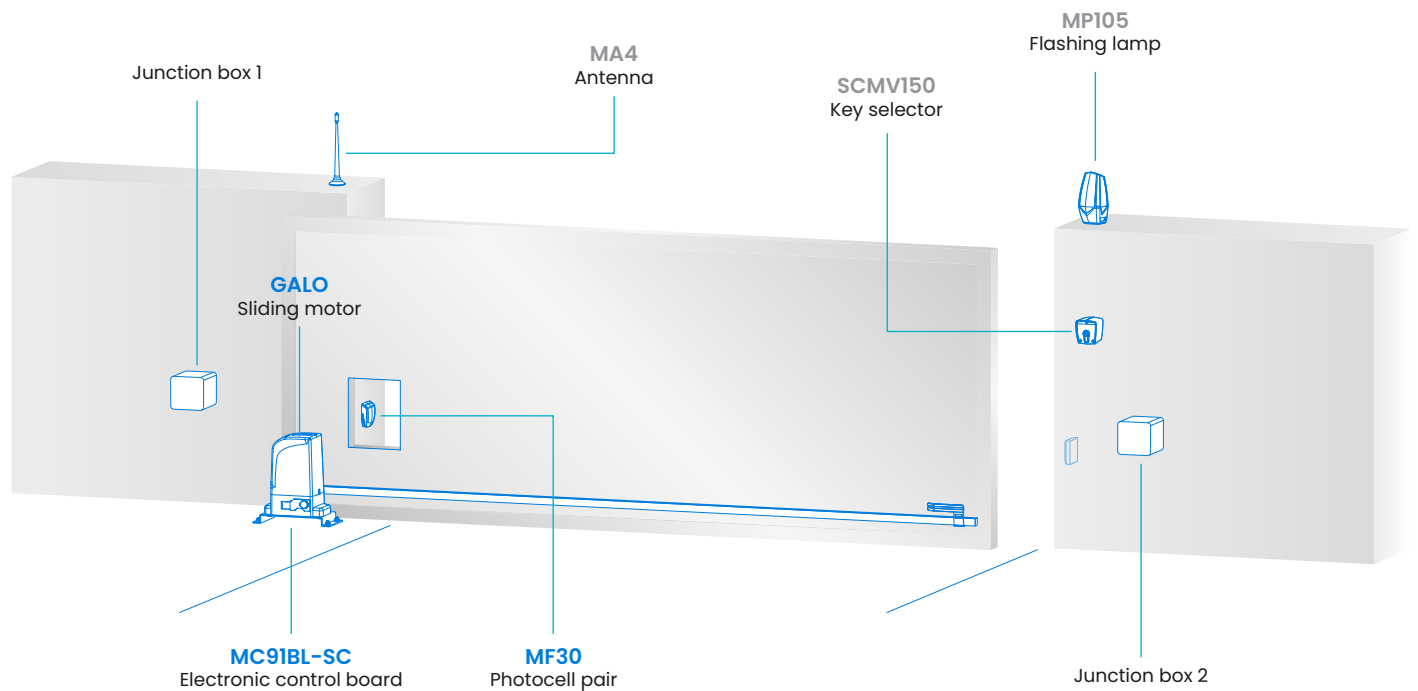

### Did you know that...

**The word GALO means rooster in Portuguese?**

The rooster of Barcelos, the birthplace of Motorline, has its origins in an ancient legend of the city and is nowadays a symbol that celebrates Barcelos tradition and Portuguese roots.

# The kit includes...



**1x**  
Brushless motor for intensive use



**1x**  
Electronic control board MC91BL-SC



**2x**  
Remote controls FALK



**1x**  
MF30  
Photocell pair

## Increase control and security Reducing the amount of wires

Increase the security of your installation by applying 8k2 safety edges to your gate and/or walls, preventing accidents such as the guillotine effect.

Using the receiver and wireless emitter establish remote and instant communication between the electronic control board and the safety edges, without running cables between them.

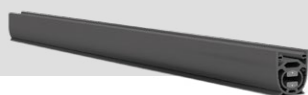

**B4 | B5**  
8k2 safety edges



**MR14**  
Receiver



**MX14**  
Wireless emitter

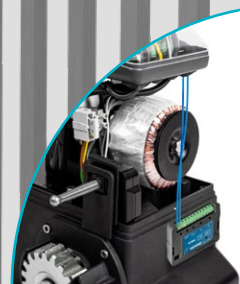

## Complete the Kit with...



**APOLO KIT**  
Solar energy system for powering 24V motors



**MFSUP**  
Column support for Photocells



**SCMV150**  
Key Selector



**MA4**  
Antenna range up to 100m



**MP105 / MP205**  
Universal LED flashing lamp

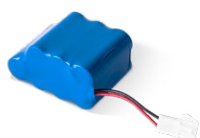

**MBAT26**  
Compact 26Vdc/1.3Ah battery with connection cable



**MMBL-BRAKE**  
Easy-to-fit module into the MC91BL-SC control board to reduce motor reversibility



Nylon, iron or stainless steel gear rack

	GALO600	GALO600 SPEED	GALO1200	GALO2200
Nominal current	7A	10A	10A	12A
Maximum absorbed current	12A	18A	18A	18A
Nominal Power	260W	360W	360W	430W
Speed	120-240mm/s	225-450mm/s	150-300mm/s	150-300mm/s
Speed with maximum weight supported	214mm/s	400mm/s	260mm/s	260mm/s
Impulse Force	450N	450N	1000N	1400N
Maximum gate weight	600 Kg	600 Kg	1200 Kg	2200 Kg
Pinion diameter	72mm	84mm	84mm	84mm
Power supply	230 Vac   50/60 Hz			
Motor power	36 Vdc			
Control board power supply	21/26 Vac			
Working frequency	55%			
Motor Technology	BLDC			
Motor reduction type	Irreversible			
Protection class	IP44			
Noise	≤50 dB			
Operating temperature	-20°C to 55°C			
Limit switch type	Magnetic/Mechanical			
Encoder	Digital native encoder			
Electronic control board	MC91BL-SC			
Backup Batteries (Optional)	MBAT26V2000			

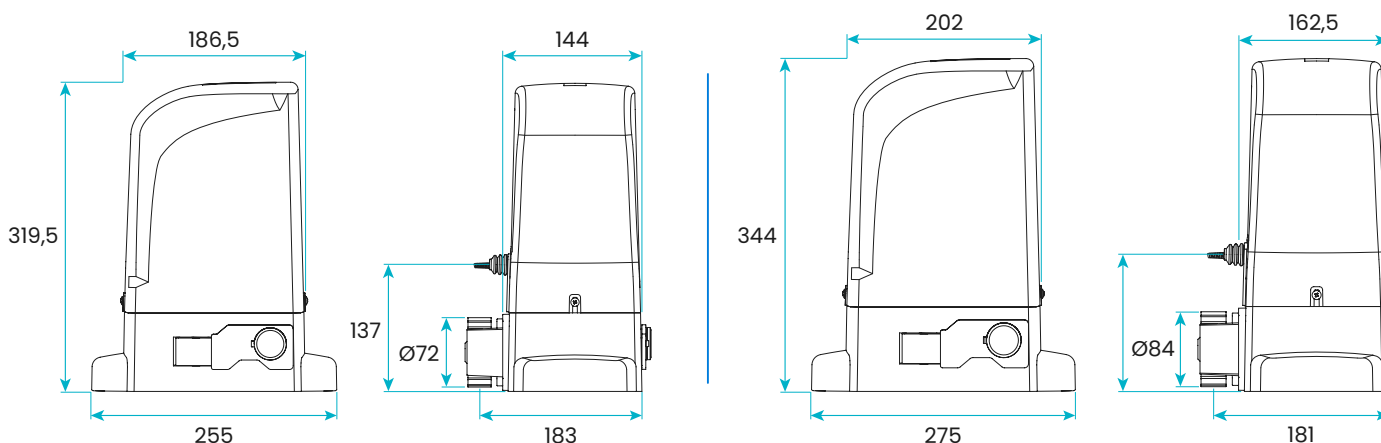

**GALO600**

**GALO600 SPEED | GALO1200 | GALO2200**

